

HOW TO...

Build a Pullback Mouse

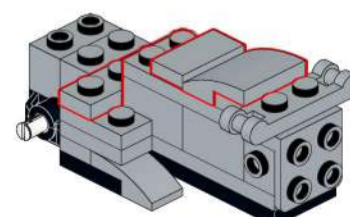

9

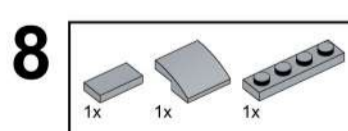
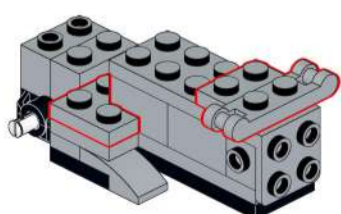
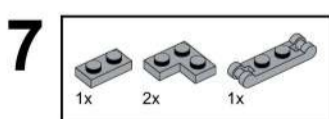
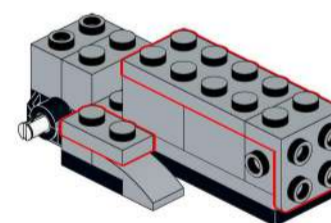
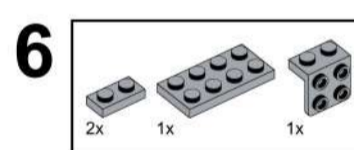
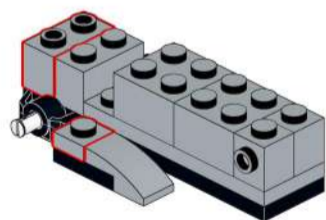
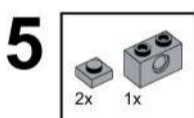
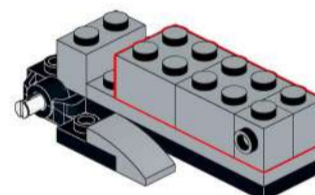
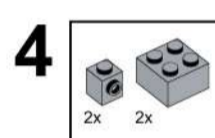
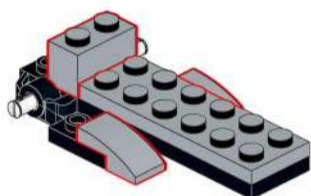
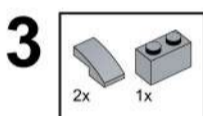
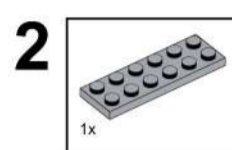
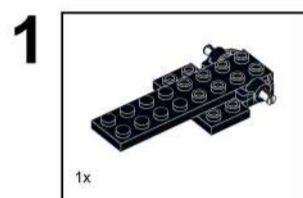
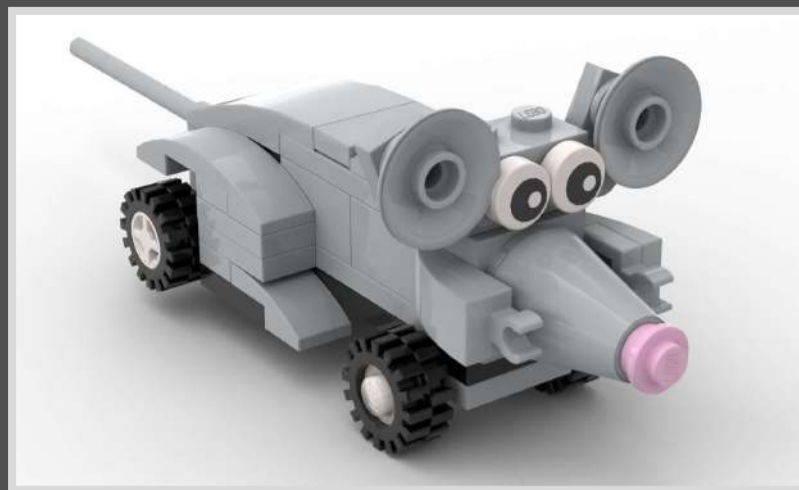
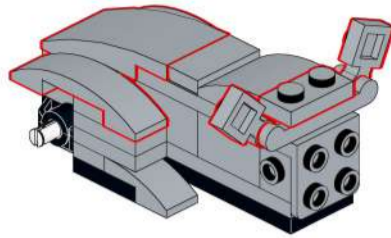
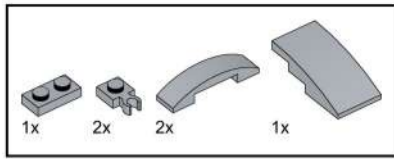

10

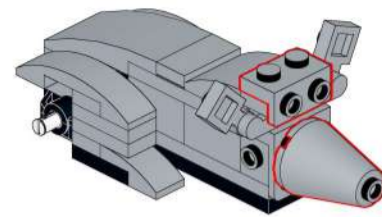
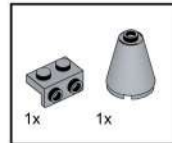

11

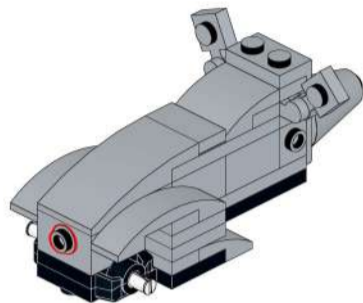

12

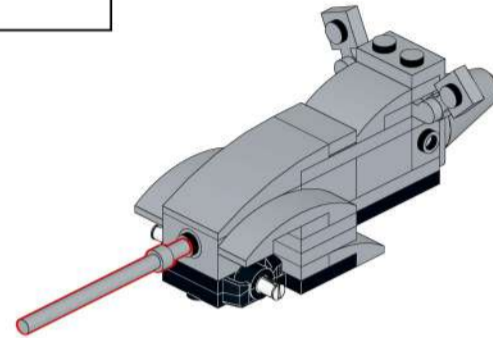
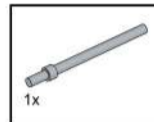

13

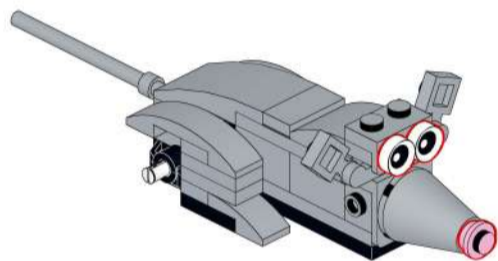
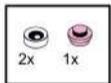

14

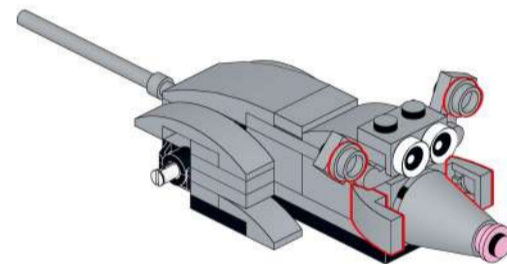
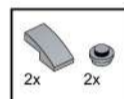

15

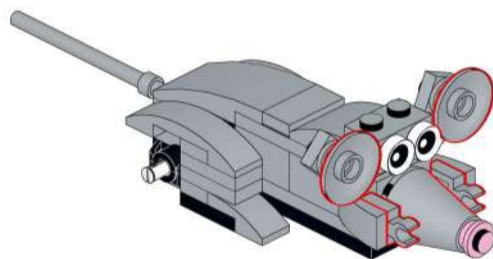
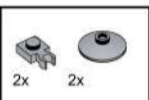

16

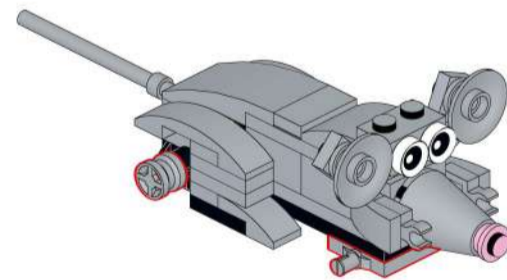
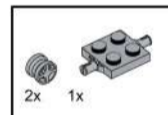

17

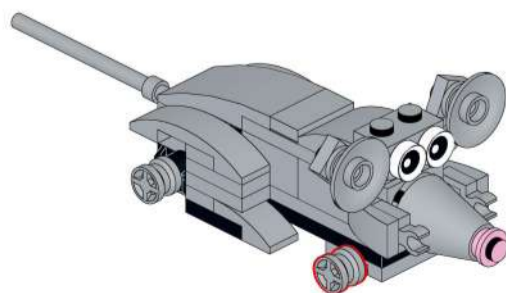

18

